

This drawing / specification is the property of MARIN DESIGN AS, and must not be copied or the contents thereof or any information received in conjunction therewith must not be imparted to any unauthorised third party. It must not be used for any other project than for which it was originally ordered. The receipt of the drawing / specification implies that the conditions mentioned herein are accepted.

MARIN DESIGN AS
N-7970 KOLVEREID
NORWAY

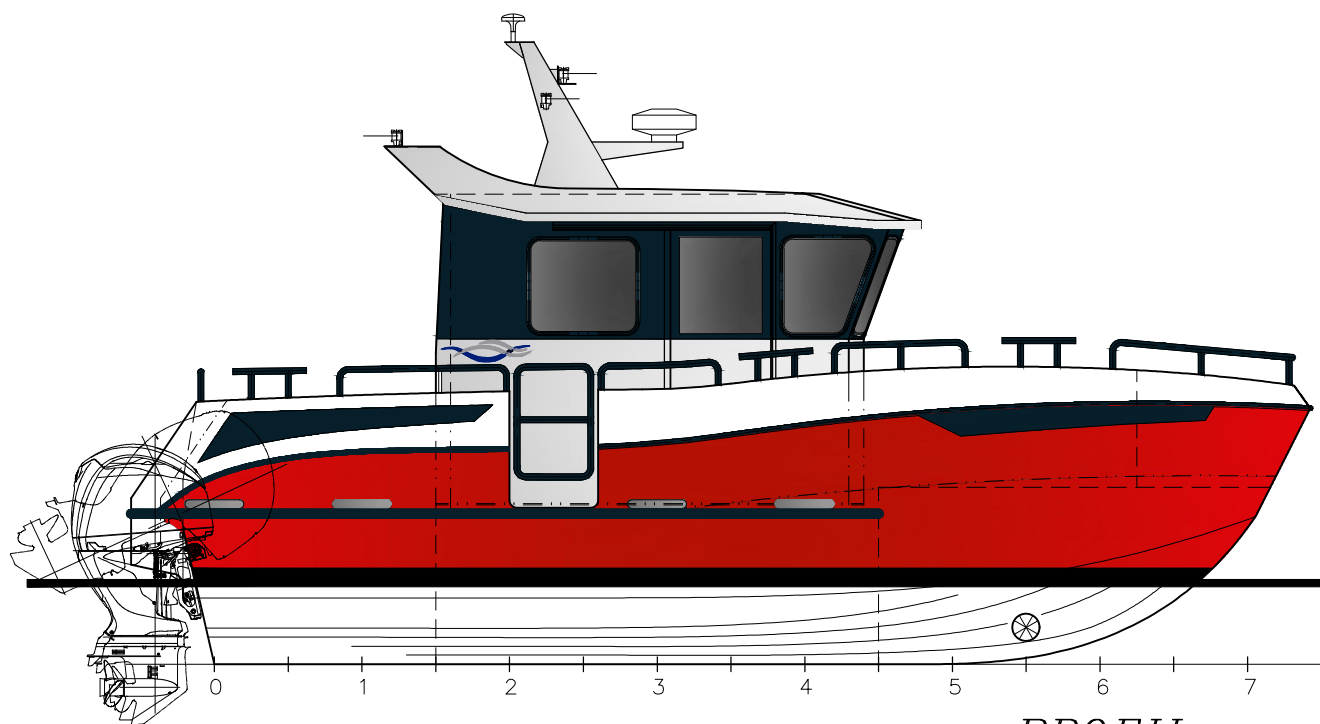

PROFIL

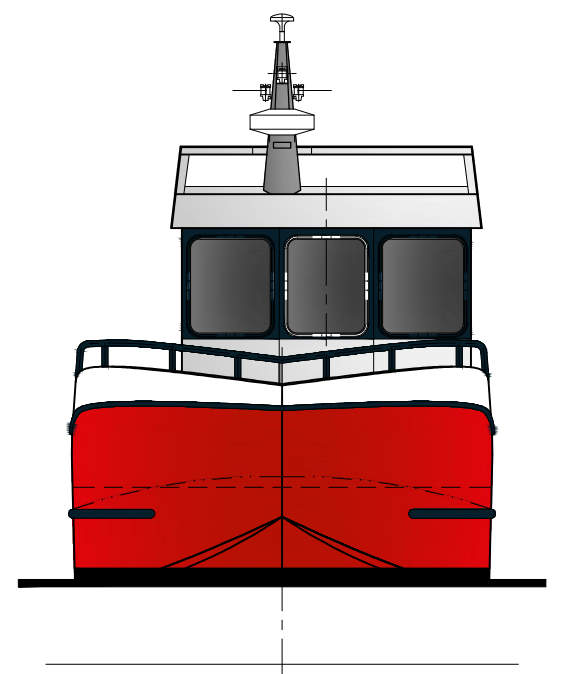

FORFRA

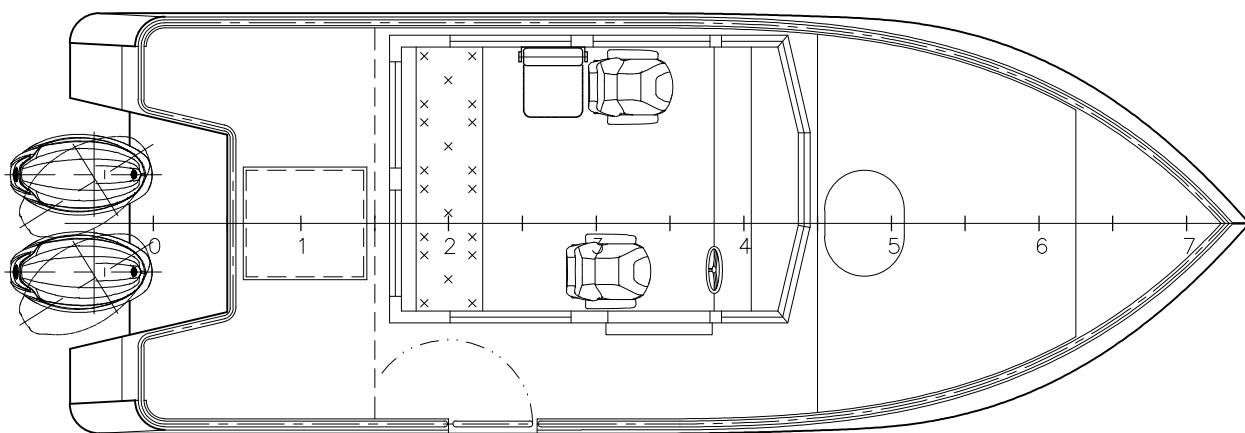

DEKK

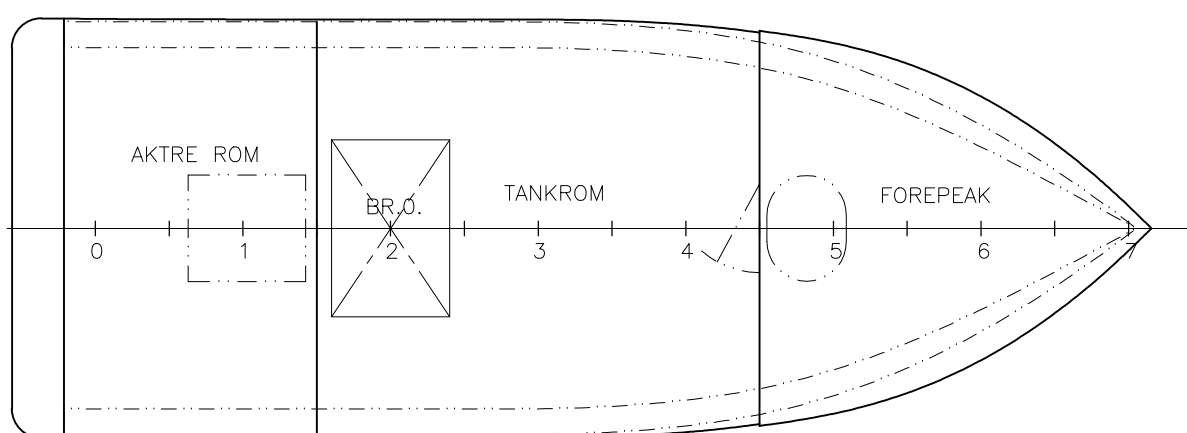

UNDER DEKK

HOVEDDATA :

LENGDE O.A. : 7.99 M
 BREDDE PÅ SPT. : 2.85 M
 DYBDE I RISS H.DEKK : 1.05 M
 SPANTAVSTAND : 1000/300 MM
 BRENNOLJE : 350 Ltr.

REV.:	DATE:	DESCRIPTION:	CONTROL:
THIS DRAWING AND/OR SPECIFICATION IS OUR PROPERTY AND IS NOT TO BE USED OR DISCLOSED FOR ANY THIRD PERSON WITHOUT OUR PERMISSION.	YARD:	OWNER :	NAME:
	OWNER:	YARD No.: XXX-Folla Maritime Service AS	SCALE: 1:50
	CLASS INST.:	 7970 Kolvereid Norway Tlf: +47 74 39 79 00 E-mail: post@marindesign.no	DATE: 18.02.25
	AUTHORITY:		DRAWN BY: AH
	APPROVED	GENERALARRANGEMENT MD-799-Offshore	CONTROL: OH
		DRAWING No.: 25130-101-001	REV.No.: 0
		PAPER SIZE: A3	